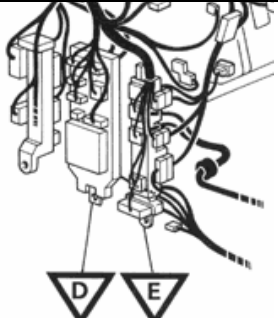
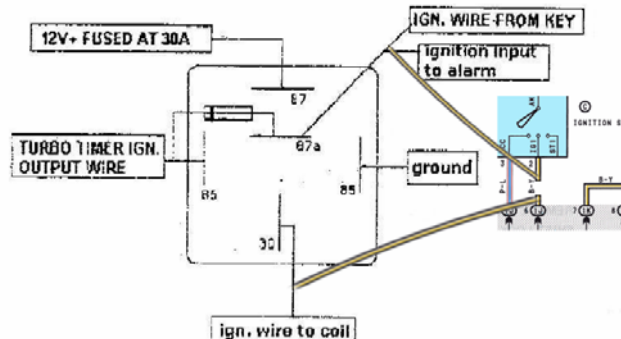
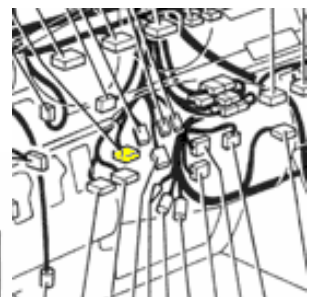
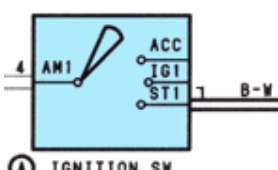
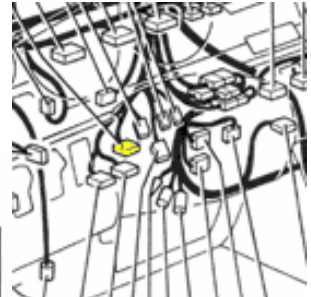

MKIII ALARM WIRE GUIDE

Deluxe LA-9324	ITEM WIRE COLOR POL WIRE LOCATION	
5 pin Red and Relay 12V	<p> 12V white (W) + driver kick panel </p> <p>MKIII Harness: IJ-2 Pages: 17, 18, 38, 39</p>	<p>12V Junction Box (3) contact points battery relay 5pin red</p>
5 pin Black	<p> chassis ground **** - driver kick panel </p> <p>MKIII Harness: E Pages: 18, 30</p> <p>(Combine with Domelight – and Relay ground) (3) contact points</p>	
5 pin Yellow	<p> IGNITION black/yellow (B-Y) + ignition harness </p> <p>MKIII Harness: I11-2 Pages: 26, 38, 39</p>	 
2 pin Brown Brown	<p> STARTER black/white(B-W) + ignition harness </p> <p>MKIII Harness: I11-7 Pages: 26, 40, 41</p>	 
8 pin Pink	<p>No connection to use Car Finder</p>	

8 pin
Green

| DOOR TRIGGER|red/white (R-W) |- |drivers kick panel |

MKIII Harness: **1N-7**
Pages: 18, 77

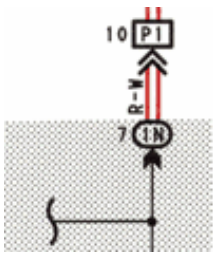
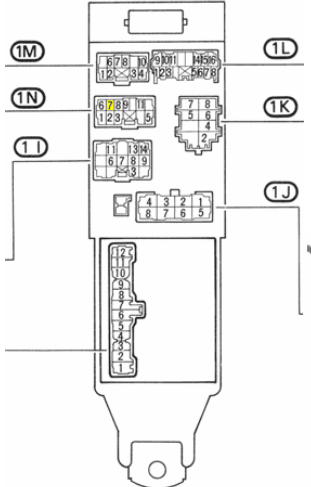
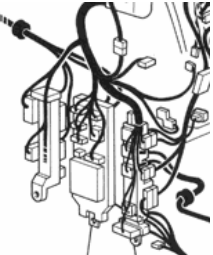
8 pin
Blue

| TRUNK/HATCH PIN|yellow/black (Y-B) |- |drivers kick panel |

MKIII Harness: **G1-1**
Pages: 32, 33, 139

8 pin
Brown

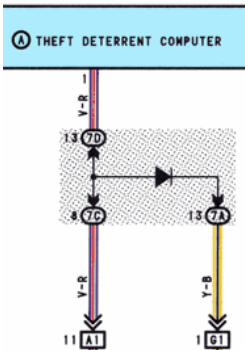
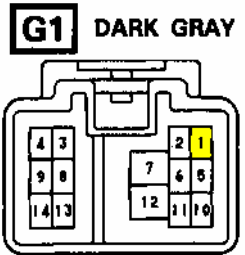
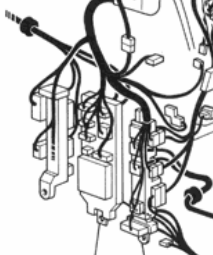
Through firewall to +12V Siren Output – Siren Brown
Connect **Siren Black** to Chassis **Ground** in engine bay

8 pin
White

| PARKING LIGHTS |green (G) |+ |drivers kick panel |

MKIII Harness: **1N-6**
Pages: 18, 70, 71

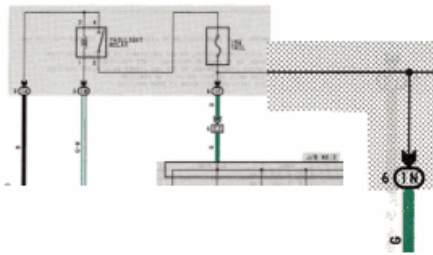
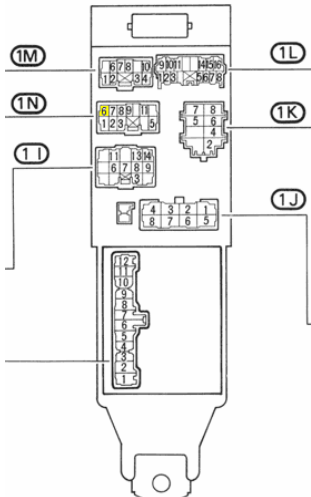
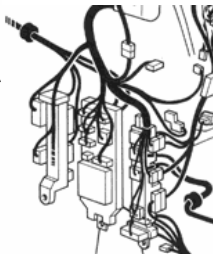
8 pin
**Black/
 White
 Stripe**
 -a

| DOMELIGHT | brown(BR) |- |drivers kick panel |

MKIII Harness: **1C-5**
 Pages: 18, 76

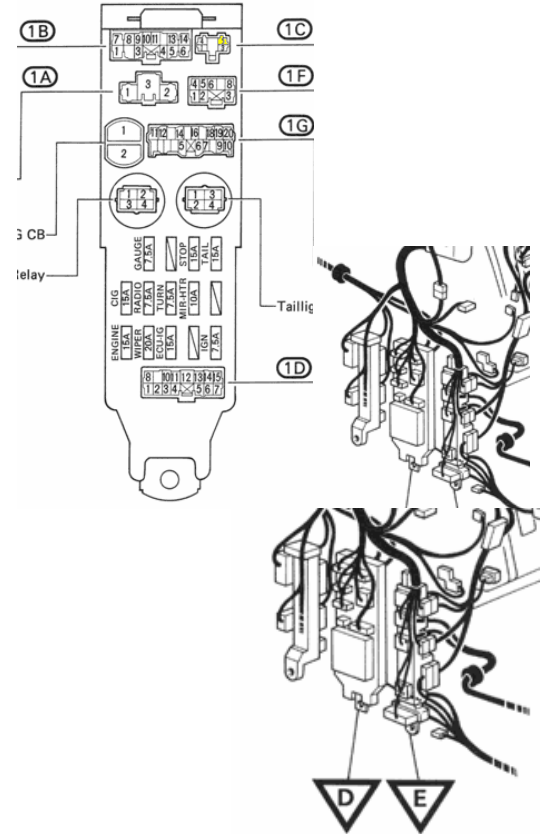
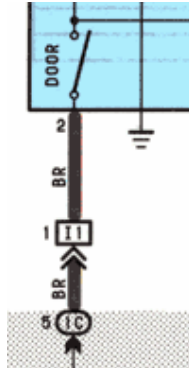

**Black/
 White
 Stripe**
 -b

| chassis ground | ** | - | driver kick panel |**

MKIII Harness: **E**
 Pages: 18, 30
 (Combine with 5 pin Black)

(Combine with **Domelight** – and **Relay** ground)
(3) contact points

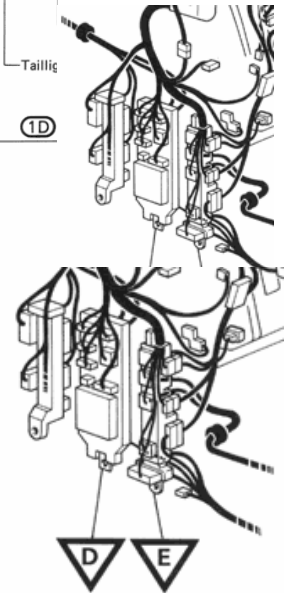

4 pin
Green

| POWER LOCK|green/yellow (G-Y) |- |either kick panel |

MKIII Harness: **D10-10**, p.27, 105, in door
 Pages: 30, 31, 103

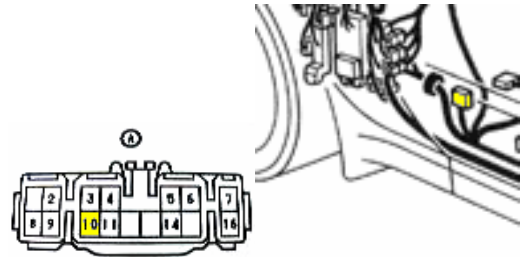
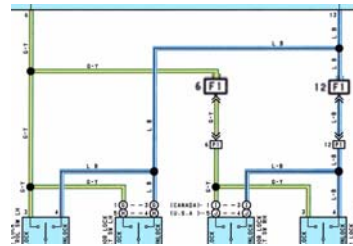

| FCTRY ALARM ARM|brown/yellow(BR-Y) |- |either kick panel |

MKIII Harness: **F1-9**
 Pages: 30, 31, 138

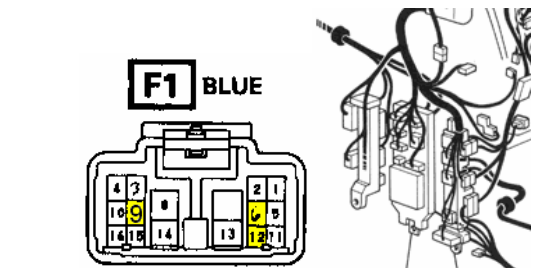
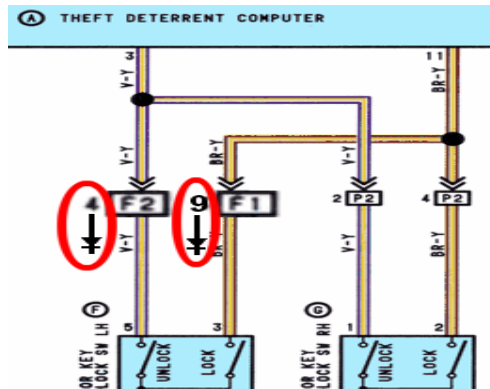

Deluxe LA-9324	2 pin Harness – Starter/EFI Disable 5 pin Harness – Main 8 pin Harness – Auxiliary 4 pin Harness – Door lock
Unused	5 pin Harness – Main Grey – Trunk Release Orange – Starter Disable non-Deluxe model 8 pin Harness – Auxiliary Violet – Positive Door Switch Trigger 4 pin Harness – Door lock Red – +12V for Aftermarket Actuators Pink – No Driver only unlock

12V	white - white/red	+	ignition harness
STARTER	black/white	+	ignition harness
IGNITION	black/yellow	+	ignition harness
SECOND IGNITION	black/orange	+	ignition harness
ACCESSORY	pink/blue	+	ignition harness
POWER LOCK	green/yellow	-	either kick panel
POWER UNLOCK	blue/black	-	either kick panel
PARKING LIGHTS	green	+	drivers kick panel
PARKING LIGHTS	pink	-	steering column
HEADLIGHTS	pur/wht and grn/red	-	steering column
DOOR TRIGGER	red/white	-	drivers kick panel
TRUNK/HATCH PIN	yellow/black	-	drivers kick panel
HOOD PIN	tied with trunk		
FCTRY ALARM ARM	brown/yellow	-	either kick panel
FCTRY ALRM DISARM	purple/yellow	-	either kick panel
TACHOMETER	black		check connector *1
BRAKE WIRE	green/white	+	drivers kick panel
HORN TRIGGER	blue/red	-	steering column
WIPERS	blue/red (lo) *2	+	steering column
LF WINDOW UP/DN	red - grn/yel	A	in drivers door
RF WINDOW UP/DN	blu/blk - blu/yel	A	in drivers door or dkp

| DOMELIGHT | brown | - | drivers kick panel |

Notes: *1 The check connector is located in the front of the left shock tower. It is a small rectangular plastic box, either black, gray, or green, and it is marked diagnostic on the lid. *2 The high position is red/blue(+) in the same location.